

Data Sheet

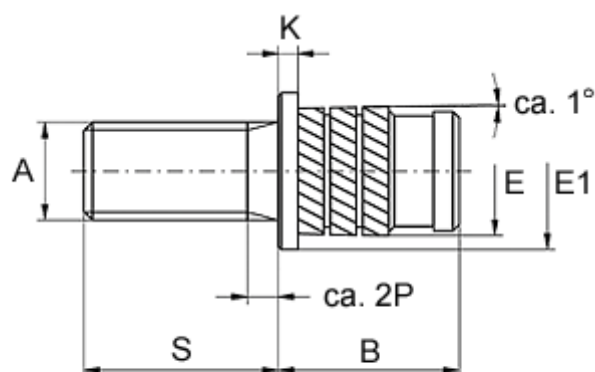

Article number: 12857000025880
Description: KLEE-coil 857 000 025.880
M2,5 Brass

Measures



Gevindlængde = $S - 2P$
P = stigning

Flange diameter E1	= 5.6
Flange height	= 0.6
Male thread A	= M2,5x0,45
Min distance to edge	= 2.0
Mounting length B	= 5.3
Outer diameter E	= 4.20
Pin length S	= 25
Recommended bore diameter	= 3.8